

Butt Weld 90 Degree Long Radius Elbow

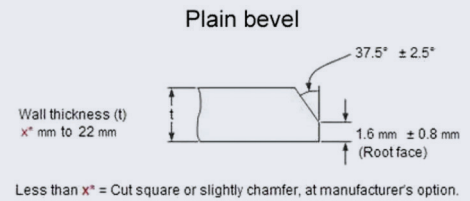
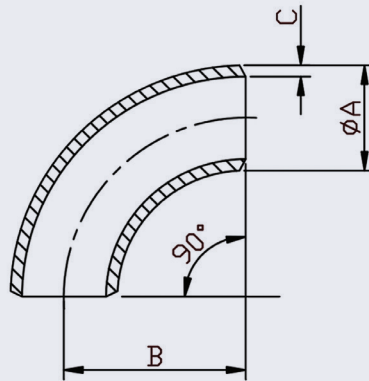

NERO's range of Butt Weld Long Radius Elbows are made to ANSI B16.9. They are available in schedule 10-40 thickness and 316/L or 304/L material grades.

Radius = 1.5D

This item is of Far Eastern origin and 3.1b material certificates are available upon request.

Size	SCHEDULE 10						SCHEDULE 40					
	PRODUCT CODE		DIMENSIONS				PRODUCT CODE		DIMENSIONS			
	316/L	304/L	A	B	C	KG EACH	316/L	304/L	A	B	C	KG EACH
1/2	BE08/1	BE08/1-304	21.3	38.1	2.11	0.06	BE08/4	BE08/4-304	21.3	38.1	2.11	0.08
3/4	BE12/1	BE12/1-304	26.6	38.1	2.11	0.07	BE12/4	BE12/4-304	26.6	38.1	2.11	0.09
1	BE16/1	BE16/1-304	33.4	38.1	2.77	0.14	BE16/4	BE16/4-304	33.4	38.1	2.77	0.16
1-1/4	BE20/1	BE20/1-304	42.1	47.6	2.77	0.23	BE20/4	BE20/4-304	42.1	47.6	2.77	0.25
1-1/2	BE24/1	BE24/1-304	48.1	57.2	2.77	0.31	BE24/4	BE24/4-304	48.1	57.2	2.77	0.40
2	BE32/1	BE32/1-304	60.3	76.2	2.77	0.51	BE32/4	BE32/4-304	60.3	76.2	2.77	0.71
2-1/2	BE40/1	BE40/1-304	73	95.2	3.05	0.85	BE40/4	BE40/4-304	73	95.2	3.05	1.36
3	BE48/1	BE48/1-304	88.9	114	3.05	1.22	BE48/4	BE48/4-304	88.9	114	3.05	2.18
4	BE64/1	BE64/1-304	114.3	152	3.05	2.15	BE64/4	BE64/4-304	114.3	152	3.05	4.17
5	BE80/1	BE80/1-304	141.3	190	3.4	3.63	BE80/4	BE80/4-304	141.3	190	3.4	6.86
6	BE96/1	BE96/1-304	168.3	228.6	3.4	4.90	BE96/4	BE96/4-304	168.3	228.6	3.4	10.89
8	BE128/1	BE128/1-304	219.08	305	3.76	10.66	BE128/4	BE128/4-304	219.08	305	3.76	21.55
10	BE160/1	BE160/1-304	273.1	381	4.19	19.55	BE160/4	BE160/4-304	273.1	381	4.19	38.56
12	BE192/1	BE192/1-304	323.9	457.2	4.57	27.22	BE192/4	BE192/4-304	323.9	457.2	4.57	59.42
14	BE224/1	BE224/1-304	356	533	4.78	39.35						
16	BE256/1	BE256/1-304	406	610	4.78	51.60						

**** Dimensions subject to change - Please contact us if critical ****

Other products you might like...

Did you know we also keep Short Radius & 45 degree Elbows?

